

Electrical Service & Wiring Installation Handbook



South Plains Electric Cooperative, Inc.

(806) 775-7766 Lubbock

(806) 271-3311 Spur

(940) 937-2565 Childress

Your Touchstone Energy® Cooperative
The power of human connections®



Revised 2/2021

TO REPORT OUTAGES

24-hour automated outage reporting
(806) 741-0111 for Lubbock local
(888) 741-0111 toll free

Information required for prompt service:

1. Name on your SPEC account

2. Meter Number

3. Account Number

FOR NEW SERVICE/BILLING INQUIRIES

Monday-Friday: 7:30 a.m. - 5:30 p.m.
(806) 775-7766

After 5:30 p.m. and on weekends
(806) 775-7732

AUTOMATED ACCOUNT INQUIRY

(806) 775-7811

SPEC.coop

Our website contains member-specific information on a variety of topics. Go online for more details.

ELECTRIC SERVICE AND WIRING INSTALLATION HANDBOOK

Foreword:

This handbook has been prepared for the convenience of our members, electrical contractors, builders and any others engaged in providing electrical wiring service in order to acquaint the reader with South Plains Electric Cooperative's requirements for electric meter installations. This handbook will establish the Cooperative's requirements for new electric service and meter installations, for relocating or modifying meter installations and upgrading the service capacity. The handbook contains specifications for both overhead and underground delivery.

The information presented in this handbook is not intended to conflict in any way with the National Electrical Code, any city or county ordinances, or any state rules. Some of the service requirements, as presented, are the result of past experience and deemed necessary to insure safe, adequate and reliable service for the member. If this handbook does not cover a particular metering situation, please contact one of our offices listed below before proceeding with your work.

Additional copies of this booklet may be obtained at any of the Cooperative's offices and online at SPEC.coop.

North Office, 110 N I-27, Lubbock
West Office, 6506 19th Street, Lubbock
(806) 775-7766
Spur Office, FM 836, Spur
(806) 271-3311
Childress Office, 1900 C NW, Childress
(940) 937-2565

INDEX

A. General Information	6
B. Think Safety!	6
C. Number of Services.....	7
D. Grounding.....	7
E. Equipment Requiring Individual Consideration ...	8
F. Inspection	8
G. Meter Tampering	9
H. Types of Service	9
1. Single Phase	
a. 120-volt, 2-wire service	9
b. 120/240-volt, 3-wire service	10
c. 240/480-volt, 3-wire service	10
2. Three Phase Service	
a. 120/240-volt, 4-wire, delta service	11
b. 480-volt, 4-wire service	11
c. 120/208-volt or 277/480-volt, 4-wire, wye connected service	12
d. 240 or 480-volt, 3-wire service, delta connected service	13
Table 1-A	
Conductor Sizing.....	14
Table 1-B	
Conduit Service Entrance Specifications.....	15

I. Building a Meter Loop.....	16
1. Irrigation Service	
a. Pedestal to submersible pump.....	16
b. Pedestal to above ground pump	17
c. Pedestal to towable pivot.....	18
d. Pedestal to stationary pivot	19
e. Service to above ground pump or submersible	20
2. Overhead Service	
a. Typical single phase temporary meter.....	21
b. Underground group metering.....	22
c. Overhead group metering.....	23
d. Minimum clearances	24-25
e. Meter remote–under eaves.....	26
f. Meter remote–through eaves	27
g. Meter base on building–through eaves.....	28
h. Meter base on building–under eaves.....	29
i. To mobile home or meter pole with underground	30
3. Underground Service	
a. Meter base on building	31
b. Metered remote	32
4. Overhead Service	
a. 2-way (in and out) loop–through eaves ...	33
b. 2-way (in and out) loop–under eaves.....	34

A. GENERAL INFORMATION

The following information has been assembled so those engaged in electrical wiring or the installation of metering equipment might comply with the service requirements of South Plains Electric Cooperative. Members and/or contractors planning new construction, altering, or rewiring existing facilities should become familiar with the requirements. If you determine after reading the handbook that your situation is not covered, please contact the Cooperative for better direction before proceeding.

South Plains Electric Cooperative will make every reasonable effort to provide our members with safe, reliable, adequate electric service. To accomplish this goal, the Cooperative should be contacted in advance of your required service date. Service availability may vary within our service area. It is always best to confer with the local office before beginning your work. It is the Cooperative's recommendation that additional capacity be provided whenever possible for future use. Permanent residential services shall have a minimum installed capacity of 100 amperes at 120/240 volts, single phase.

The information in this handbook refers to service requirements for lighting and power installations at secondary voltages. Services requiring primary voltages are subject to a contractual agreement between the member and the Cooperative, and the metering requirements will be determined at that time.

B. THINK SAFETY!

Before you dig — Call 811. Texas state law requires that you call before you dig or disturb the ground. With 48-hour advance notice, each involved utility will mark the location of their facilities in the easement. They will not locate any services between the easement and your house or other building. Those must be located by a local contractor.

Warning — It is unlawful for you to operate any equipment within ten (10) feet of a high voltage line. If you must work close to any of the Cooperative's electrical lines, please contact your local office. Your Cooperative will assist you in performing your needed work safely.

Look Up! We further recommend that you do not stack any irrigation pipe under electric lines and certainly be aware of power lines when erecting or working on antenna towers. Many of our members operate farming equipment near or under our lines, please be mindful of the clearance requirements for this equipment as you perform various functions in the field and travel into and out of the fields.

C. NUMBER OF SERVICES

The Cooperative will normally connect only one set of service conductors to a home or building. The member will provide for metering in a location acceptable to the Cooperative.

Large apartment buildings, shopping centers and industrial complexes may require special applications of the National Electrical Code. The Cooperative should be contacted during the design stage for these projects to obtain guidance and agreement on the interpretations of these special metering considerations.

D. GROUNDING

All service systems operating below 600 volts shall contain a grounded neutral or a grounded phase conductor used as a circuit conductor in the system. The neutral or grounded phase conductor shall be grounded at the supply transformer and shall be connected to the grounding terminal in the service entrance equipment provided by the member. The NEC requires an adequate grounding system as part of the wiring with a grounding conductor tied to the service

entrance raceway and to the neutral terminal in the disconnecting means. All of these connections to the grounding conductor shall be accessible for inspection by Cooperative personnel.

Members requiring an *ungrounded service* for operation of a ground detection system shall make their request in writing. If supplying an ungrounded service results in additional costs to the Cooperative, the additional cost may be passed on to the member.

E. EQUIPMENT REQUIRING INDIVIDUAL CONSIDERATION

Providing service for power consuming equipment such as welders, large motors, high frequency induction furnaces, or sensitive electronic equipment may require individual consideration and agreement by the Cooperative. By design, the Cooperative can minimize the emission or distortions on the electrical system. One member will not be permitted to affect the service quality of another member. By understanding the equipment's power requirements in these special situations, the Cooperative can make certain that each member can coexist with their neighbor.

Sometimes, the equipment may require very stable voltage, system isolation, or uninterrupted continuity of service. The Cooperative, by agreement, may be able to supply service level requirements that are above the normally acceptable levels. The Cooperative desires to assist its members with any special equipment problems especially during the planning and design stages of the projects.

F. INSPECTION

The wiring shall be installed in accordance with the latest requirements of the National Electrical Code (NEC) and any state or county or municipal

inspection requirements as may be in force at the time the installation is completed.

All wiring and other electrical equipment will be installed, operated, and maintained by the member at all times in conformity with good electrical practice and the requirements of the regional regulatory authority. The inspecting authority will leave an inspection tag on the member's service entrance equipment to notify the Cooperative that the wiring is approved for service connection. In areas where there is no inspection authority, the Cooperative's personnel will inspect the service entrance for compliance to the NEC. The Cooperative does not assume any responsibility for the design, operation, or condition of the member's wiring past the service entrance equipment.

G. METER TAMPERING

The metering equipment belongs to the Cooperative and must not be disconnected, removed or relocated except by authorized Cooperative personnel. The Cooperative shall seal all meters and meter installation equipment. Law forbids tampering with the meter or with conductors carrying metered current. If it is necessary to gain access to any metering equipment that has been sealed by the Cooperative, the member or his contractor shall contact the service department for inspection and resealing of the meter after the work has been completed.

H. TYPES OF SERVICE

1. Single-Phase Service

a. 120-volt, 2-wire service

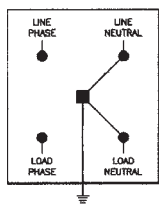

NOTE: 2 WIRE SERVICE,
MAX 100 AMP
LEFT SIDE PHASE (HOT)
RIGHT SIDE NEUTRAL (GROUND)

This type of service may be used to serve a small electrical load not having any 240-volt requirements such as a sign, fence charger, or fireworks stand. The maximum meter capacity is 60 amperes.

b. 120/240-volt, 3-wire service

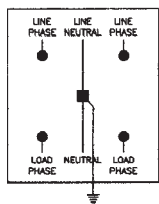

NOTE: 3 WIRE SERVICE,
100 AMP OR 200 AMP
PHASE-GROUND-120V
PHASE-PHASE-240V

This type of service is the most typical electrical service and may be used to serve loads such as a residence, ranch or farming operation, mobile home, hunting cabin, domestic well, or small commercial office building. Normally, the service capacity is 100 or 200 amperes. If the service requirements are 400 amperes or greater, contact your local office for special metering instructions.

c. 240/480-volt, 3-wire service

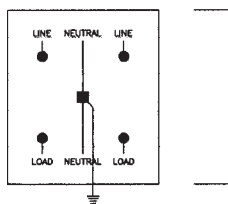

NOTE: 3 WIRE SERVICE,
200 AMP
PHASE-GROUND-240V
PHASE-PHASE-480V

This is a special service normally used by the Texas Highway Department for highway lighting.

2. Three-Phase Service

a. 120/240-volt, 4-wire, delta service

120/240-volt, 3-phase, 4-wire for domestic service

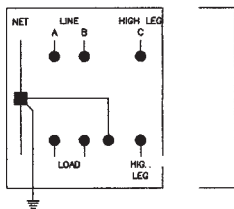

NOTE: 4 WIRE SERVICE 200 AMP
A PHASE-GROUND 120 V
B PHASE-GROUND 120 V
C PHASE-GROUND 208 V
PHASE-PHASE 240 V
BASE MUST BE 7 TERMINAL

This is the most common three phase electric service and is used for commercial, home, and some irrigation loads. Members use this voltage for small three phase loads with some lighting requirements. This service voltage works well in overhead distribution systems; however, it is not available in underground distribution applications.

b. 480-volt, 4-wire service

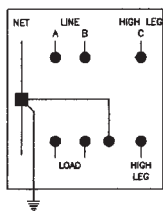

480-volt, 3-phase, 4-wire*4 for irrigation service

NOTE: 4 WIRE SERVICE 200 AMP
 A PHASE-GROUND 240 V
 B PHASE-GROUND 240 V
 C PHASE-GROUND 416 V
 PHASE-PHASE 480 V
 BASE MUST BE 7 TERMINAL

It is common on irrigation and oil field applications. This is a common electric service for irrigation pivot system with wells and/or booster pumps. It is also available for oil wells and industrial loads.

c. 120/208-volt or 277/480-volt, 4-wire, wye connected service

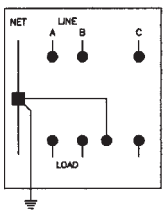

120/208 VOLT, 4 WIRE, 3 PHASE WYE

NOTE: 4 WIRE SERVICE 200 AMP
 A PHASE-GROUND 120 V
 B PHASE-GROUND 120 V
 C PHASE-GROUND 120 V
 PHASE-PHASE 208 V
 BASE MUST BE 7 TERMINAL

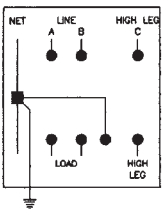

277/480 VOLT, 4 WIRE, 3 PHASE WYE

NOTE: 4 WIRE SERVICE 200 AMP
 A PHASE-GROUND 277 V
 B PHASE-GROUND 277 V
 C PHASE-GROUND 277 V
 PHASE-PHASE 480 V
 BASE MUST BE 7 TERMINAL

This wye connected electrical system is used where there is large lighting load and three phase motor load. This system permits the balancing of the lighting load across all three phases of the system. This type of service is used in schools, churches, commercial complexes and industrial parks. This is the preferred service for underground applications.

d. 240/480-volt, 3-wire service, delta connected service

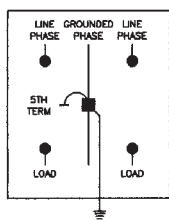

240 VOLT, 3 WIRE, 3 PHASE

NOTE: 3 WIRE SERVICE 200 AMP
 PHASE-GROUND 240 V
 PHASE-PHASE 240 V
 CENTER PHASE GROUNDED
 BASE MUST HAVE 5TH TERMINAL

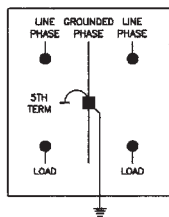

480 VOLT, 3 WIRE, 3 PHASE

NOTE: 3 WIRE SERVICE 200 AMP*
 PHASE-GROUND 480 V
 PHASE-PHASE 480 V
 CENTER PHASE GROUNDED
 BASE MUST HAVE 5TH TERMINAL

This is a common electric service for an irrigation pivot system with wells and/or booster pumps. It is also available for oil wells and industrial loads. This is a restricted use service.

***All New Installations Shall Be 4 Wire**

**Table 1-A
Conductor Sizing**

Main Fuse or Circuit Breaker Amp Rating	Minimum Size Conductors			
	Copper		Aluminum	
	Line	Neut.	Line	Neut.
60	6	6	4	6
100	2	4	1/0	2
150	1/0	2	2/0	2
200	3/0	1/0	4/0	1/0

NOTE: Table 1-A is intended as a guide only and represents only minimum capacities. It is not conclusive for all installations.

Table 1-B**Conduit Service Entrance Specifications**

(Applicable to service entrances on dwellings or other buildings and to service entrances on poles supplying overhead or underground feeders.)

Maximum Size Fuse or Breaker	Insulated Wire Size		Insulation Type	Number of Insulated Wires	Minimum Conduit Size
	Copper	Alum.			
60	6	—	TW	2	3/4"
	6	—		4	1"
	—	4		2	1"
	—	4		4	1 1/4"
100	2	—	THW*	2	1 1/4"
	2	—		2	1 1/4"
	—	1/0	THW*	2	1 1/4"
	—	1/0		4	2"
150	1/0	—	THW*	2	1 1/2"
	1/0	—		4	2"
	—	2/0		2	1 1/2"
	—	2/0		4	2"
200	3/0	—	THW*	2	1 1/2"
	3/0	—		4	2"
	—	4/0		2	2"
	—	4/0		4	2 1/2"

*RHW insulation is also acceptable.

Overhead Rigid metal conduit, intermediate metal conduit, electrical metallic tubing, service entrance cables.

Underground Rigid metal conduit, intermediate metal conduit, non-metallic electrical conduit, minimum schedule 40 PVC.

I. BUILDING A METER LOOP

Irrigation Service Pedestal to Submersible Pump

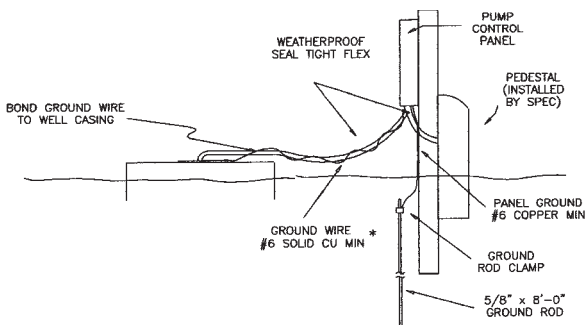

- * GROUNDING NOTE:
A SECOND GROUND ROD AT THE WELL MAY BE
SUBSTITUTED FOR THE GROUND WIRE FROM
THE PUMP CONTROL PANEL TO THE WELL CASING

NOTE:
CONDUIT BETWEEN PUMP PANEL AND
PUMP SHOULD BE BURIED IF THE DISTANCE
IS GREATER THAN 10 FEET OR IF THE
CONDUIT IS SUBJECT TO DAMAGE FROM
FARM EQUIPMENT OR OTHER VEHICLES

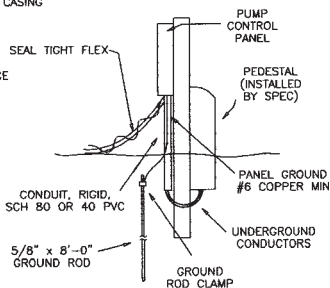

ALTERNATIVE METHOD FOR ROUTING
CONDUCTORS FROM PEDESTAL TO PUMP PANEL

Irrigation Service

Pedestal to Above Ground Pump

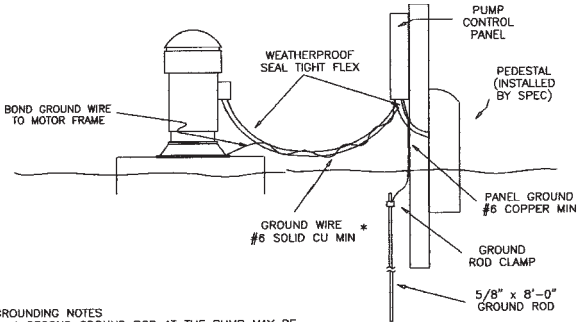

- * GROUNDING NOTES
1. A SECOND GROUND ROD AT THE PUMP MAY BE SUBSTITUTED FOR THE GROUND WIRE FROM THE PUMP CONTROL PANEL TO THE PUMP
 2. THE GROUND WIRE MAY BE RUN INSIDE THE CONDUIT PROVIDED IT IS ATTACHED TO THE FRAME OF THE PUMP

NOTE:
CONDUIT BETWEEN PUMP PANEL AND PUMP SHOULD BE BURIED IF THE DISTANCE IS GREATER THAN 10 FEET OR IF THE CONDUIT IS SUBJECT TO DAMAGE FROM FARM EQUIPMENT OR OTHER VEHICLES

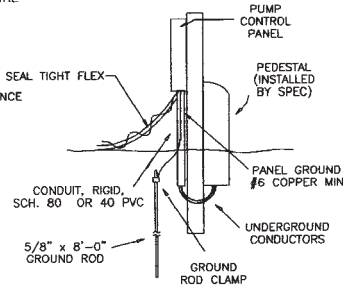

ALTERNATIVE METHOD FOR ROUTING CONDUCTORS FROM PEDESTAL TO PUMP PANEL

Irrigation Service Pedestal to Towable Pivot

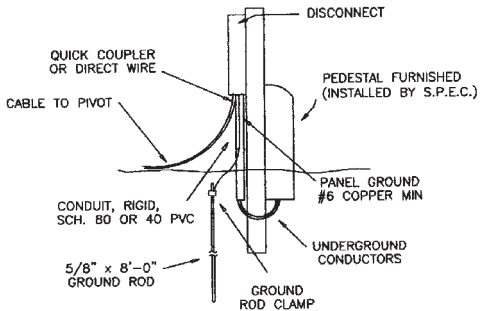
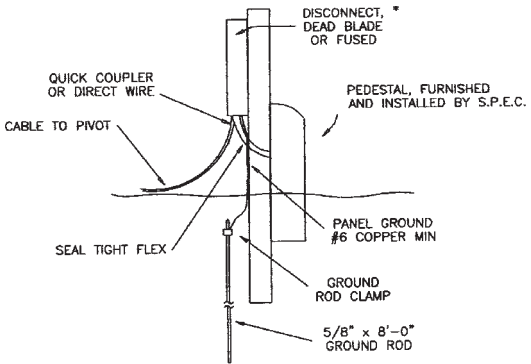

* NOTE:
DISCONNECT MAY BE INSTALLED AHEAD OF
THE PIVOT ATTACHMENT POINT, SUCH AS AT THE
ROAD OR METERING POINT

Irrigation Service Pedestal to Stationary Pivot

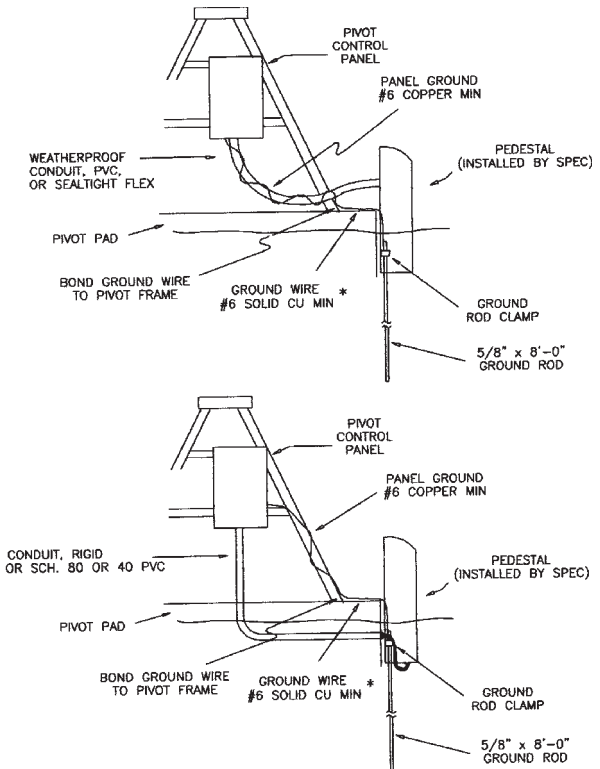

* GROUNDING NOTE:
THE GROUND WIRE MAY BE RUN INSIDE THE CONDUIT
PROVIDED IT IS ATTACHED TO THE PIVOT FRAME

Irrigation Service

Service to Above Ground Pump or Submersible

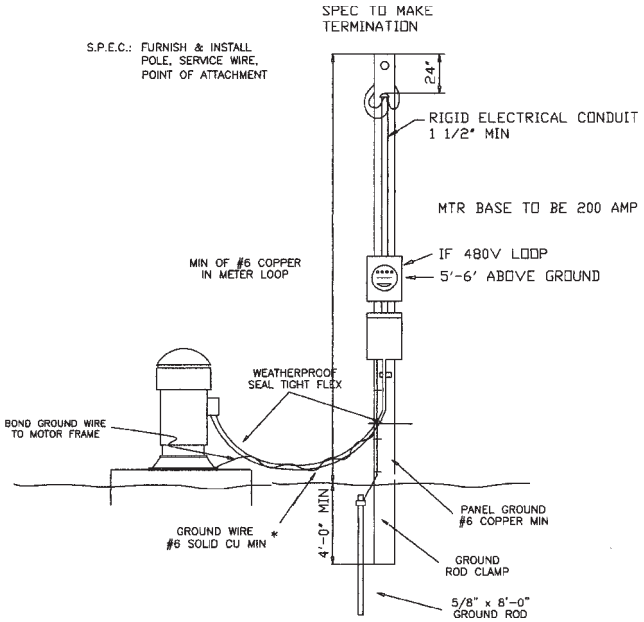

Overhead Service

Typical Single Phase Temporary Meter

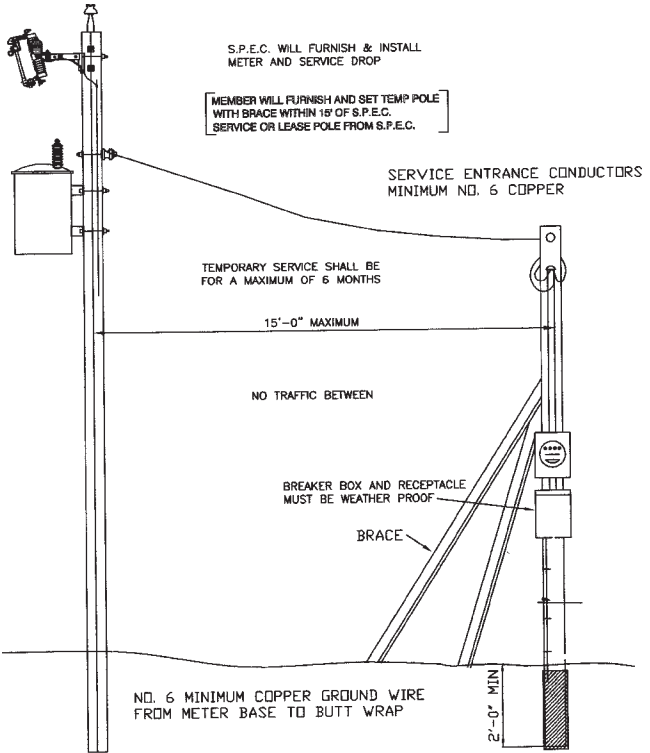

Underground Service Underground Group Metering

ALL METER ENCLOSURES AND DEVICES SHALL BE BONDED TO AN APPROVED GROUND, WITH #6 COPPER OR LARGER

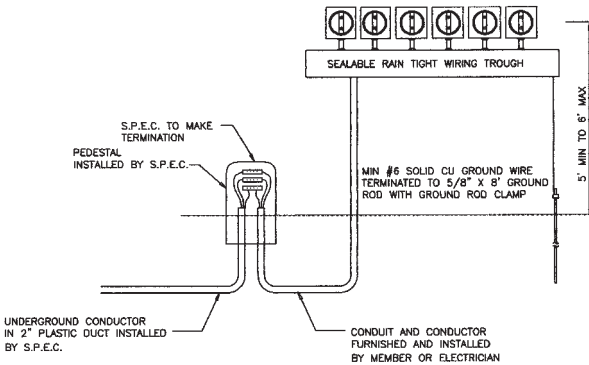

NOTE: NEC 230-40
EXCEPTION NO. 2
MAX 6 SERVICE ENTRANCES
IN A GROUP AT ONE LOCATION

NEC 230-3
SERVICE CONDUCTORS SUPPLYING A BLDG
OR OTHER STRUCTURE SHALL NOT PASS
THROUGH THE INTERIOR OF ANOTHER BLDG
OR OTHER STRUCTURE (SEE COMMENTS NEXT PAGE)

Overhead Service Overhead Group Metering

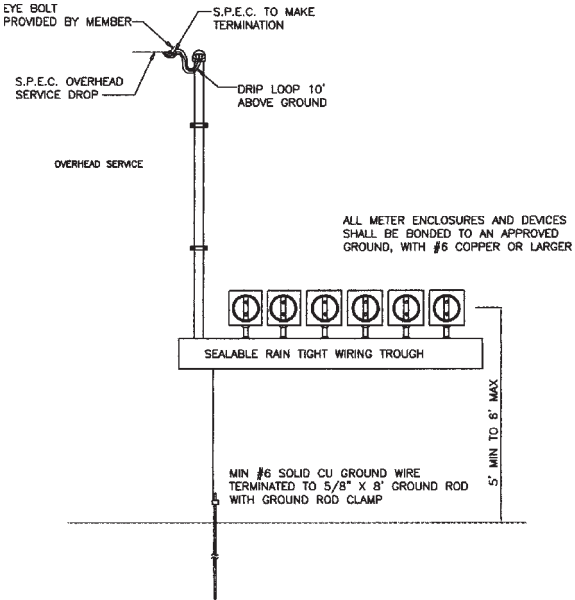

NOTE: NEC 230-40
EXCEPTION NO. 2
MAX 6 SERVICE ENTRANCES
IN A GROUP AT ONE LOCATION

NEC 230-3
SERVICE CONDUCTORS SUPPLYING A BLDG
OR OTHER STRUCTURE SHALL NOT PASS
THROUGH THE INTERIOR OF ANOTHER BLDG
OR OTHER STRUCTURE (SEE COMMENTS NEXT PAGE)

Overhead Service Minimum Clearances

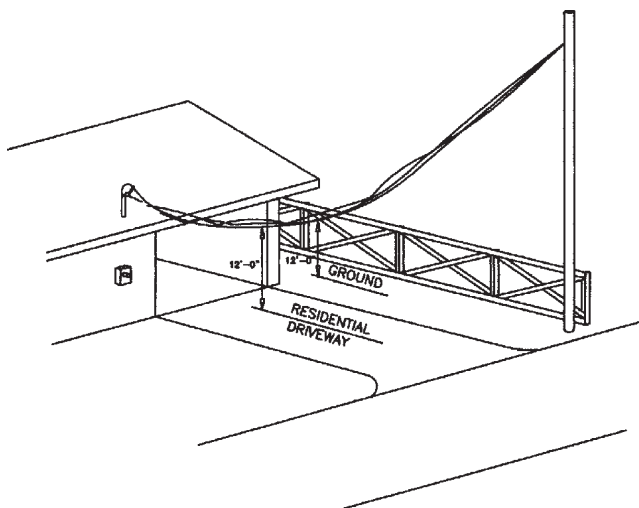

Overhead Service Minimum Clearances

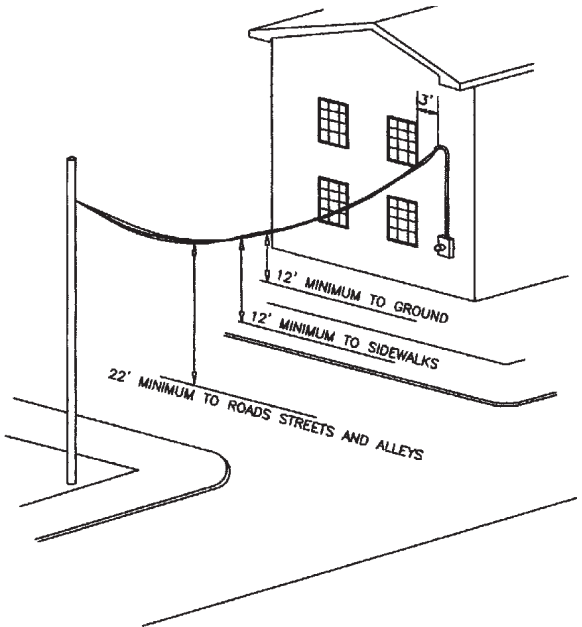

Overhead Service Meter Remote—Under Eaves

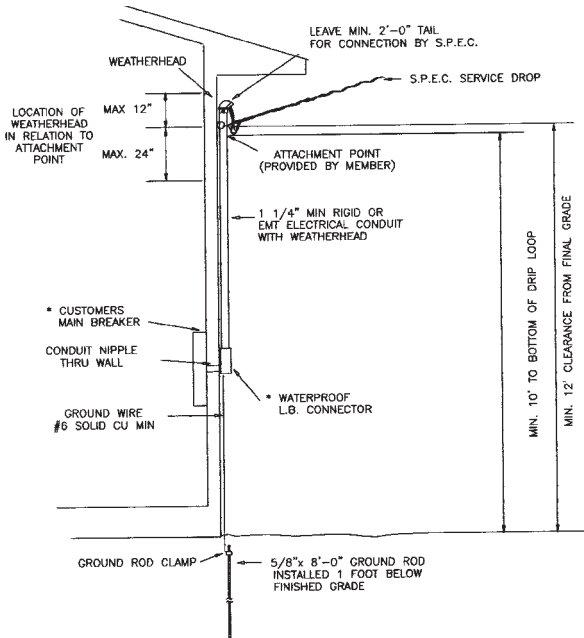

* INTERIOR MAIN MUST BE ON BACK SIDE
OF L.B. CONNECTOR WITH NIPPLE IN BETWEEN
L.B. CONNECTOR AND MAIN, IF NOT, RAIN TIGHT
MAIN IS REQUIRED IN PLACE OF L.B. CONNECTOR

Overhead Service Meter Remote—Through Eaves

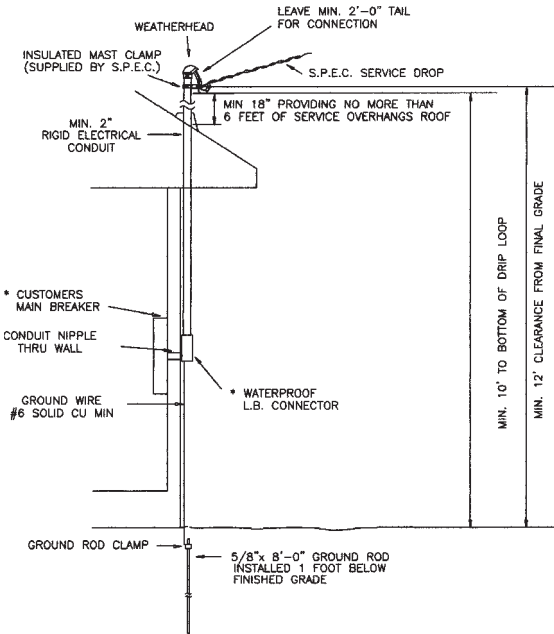

* INTERIOR MAIN MUST BE ON BACK SIDE OF L.B. CONNECTOR WITH NIPPLE IN BETWEEN L.B. CONNECTOR AND MAIN, IF NOT, RAIN TIGHT MAIN IS REQUIRED IN PLACE OF L.B. CONNECTOR

Overhead Service Meter Base on Building—Through Eaves

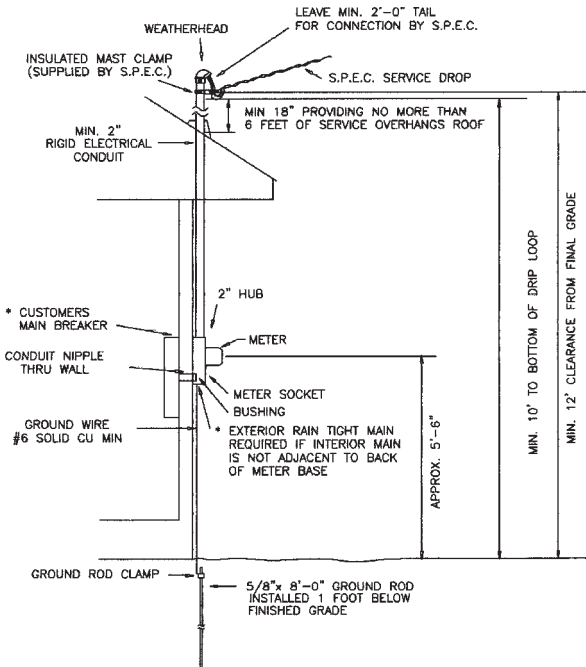

* INTERIOR MAIN MUST BE ON BACK SIDE OF METER BASE WITH NIPPLE IN BETWEEN METER BASE AND MAIN, IF NOT, EXTERIOR RAIN TIGHT MAIN IS REQUIRED

Overhead Service Meter Base on Building—Under Eaves

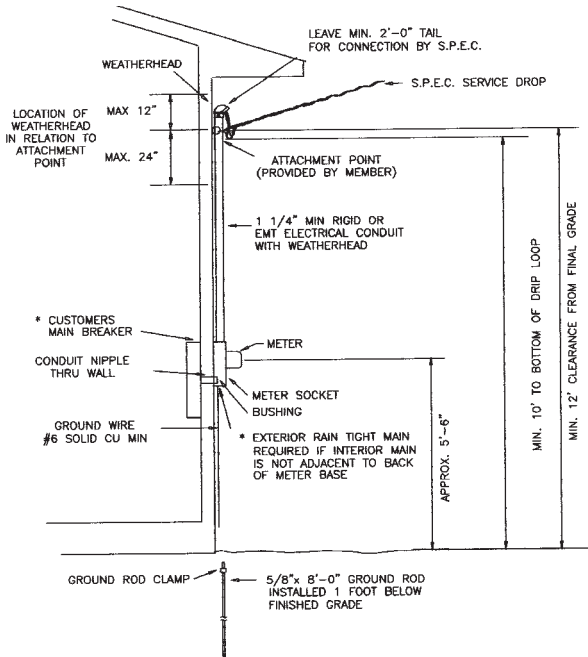

* INTERIOR MAIN MUST BE ON BACK SIDE OF METER BASE WITH NIPPLE IN BETWEEN METER BASE AND MAIN, IF NOT, EXTERIOR RAIN TIGHT MAIN IS REQUIRED

Overhead Service To Mobile Home or Meter Pole with Underground

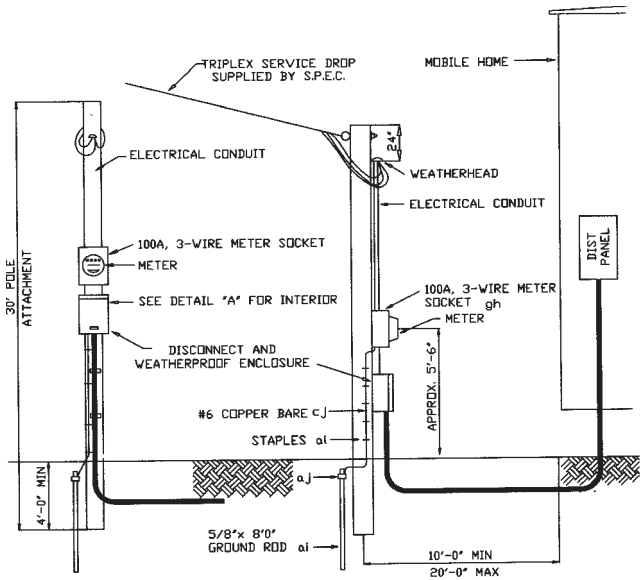

Underground Service Meter Base on Building

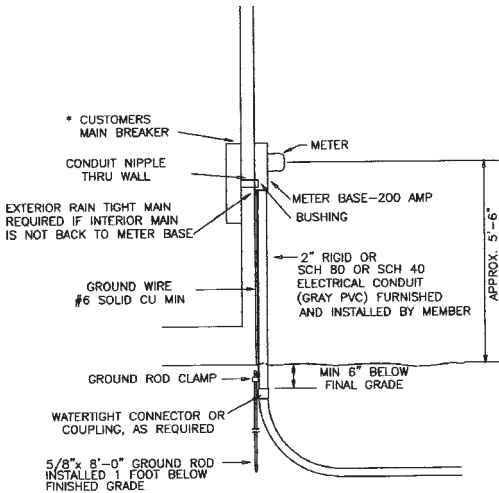

* INTERIOR MAIN MUST BE ON BACK SIDE OF METER BASE WITH NIPPLE IN BETWEEN METER BASE AND MAIN, IF NOT, EXTERIOR RAIN TIGHT MAIN IS REQUIRED

Underground Service Metered Remote

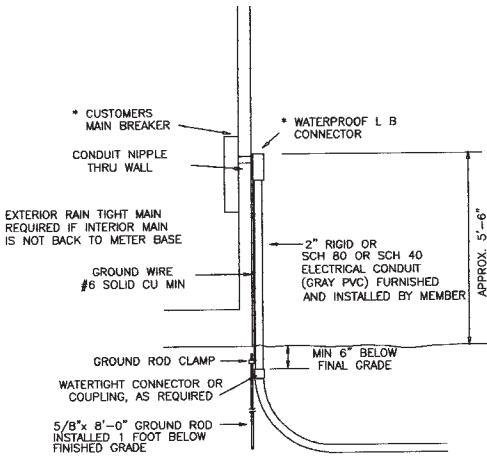

* INTERIOR MAIN MUST BE ON BACK SIDE OF L.B. CONNECTOR WITH NIPPLE IN BETWEEN L.B. CONNECTOR AND MAIN, IF NOT, RAIN TIGHT MAIN IS REQUIRED IN PLACE OF L.B. CONNECTOR

Overhead Service 2-Way (in and out) Loop Through Eaves

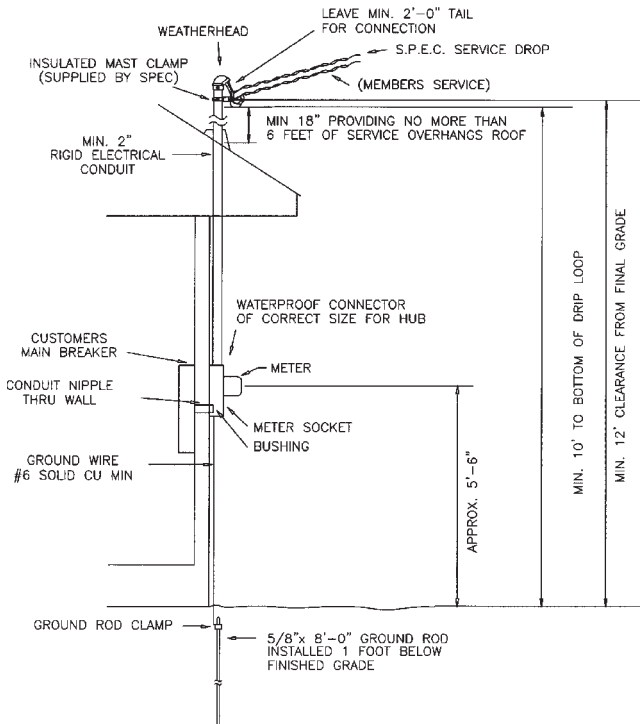

Overhead Service 2-Way (in and out) Loop Under Eaves

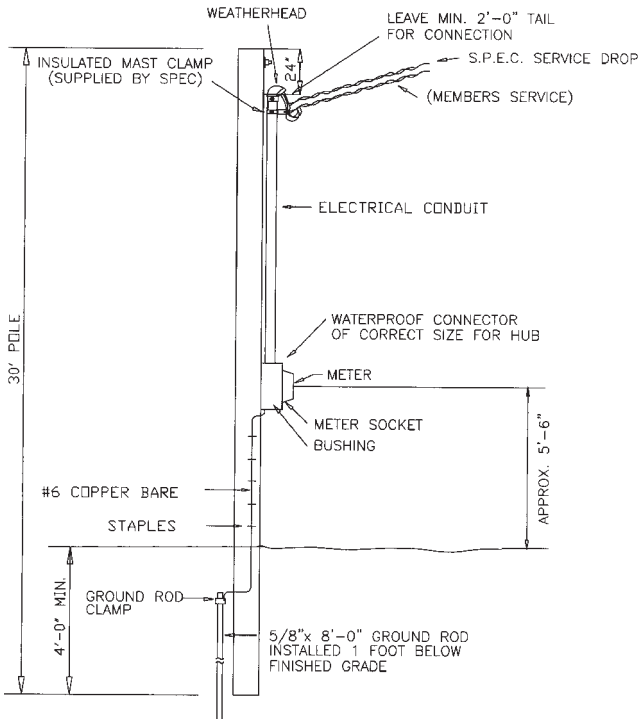

Notes

Because **ONE**
size doesn't
fit **ALL!**



We understand that one size doesn't fit all. That's why we provide a variety of ways for you to pay your bill and manage your account at your convenience.

Let us help you find your **PERFECT FIT!**

Visit SPEC.coop/allthewaystopay to learn more!

Service offices located at:

6506 19th Street, Lubbock

110 N. I-27, Lubbock

Farm Road 836, Spur

1900 Ave. C NW, Childress